

Brass fittings commonly used in orifice controlled, centralized oil lubrication systems such as Bijur, Shawa, Trico, Lube USA, etc.

FITTINGS

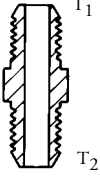
Illustration	New Model No.	T1	T2
 Male Thread Connector	FC-1002	5/16-24	5/16-24
	FC-1008	5/16-24	1/8 NPT
	FC-1000	1/8 NPT	1/8 NPT
	FC-1003	1/8 NPT	3/8-24
	FC-1004	1/8 NPT	7/16-24
	FC-1005	1/4 NPT	1/8 NPT
	FC-1006	1/4 NPT	7/16-24
	FC-1007	1/4-28 Zerk	1/4-28 Zerk
	FC-1002M	M8 x 1.0	M8 x 1.0
	FC-1000M	1/8 BSPT	1/8 BSPT
	FC-1014	1/8 BSPT	1/8 NPT
	FC-1015	M8 x 1.0	1/8 NPT
	FC-1010M	1/4 BSPT	1/4 BSPT
FC-1017	1/8 BSPT	5/16-24	

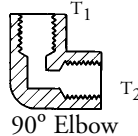
Illustration	Model No.	T1	T2
 90° Elbow	FE-1005	5/16-24	5/16-24
	FE-1000	5/16-24	1/8 NPT
	FE-1012	1/8 NPT	1/8 NPT
	FE-1000M	M8 x 1.0	M8 x 1.0
	FE-1001M	M10 x 1.0	M10 x 1.0


Illustration	Model No.	T1	T2
 90° Street Elbow	FE-1007M	M8 x 1.0	1/8 BSPT
	FE-1011M	M8 x 1.0	M8 x 1.0
	FE-1010M	1/8 BSPT	1/8 BSPT

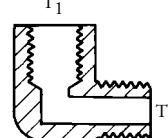
Illustration	Model No.	T1	T2
 90° Street Elbow	FE-1002	5/16-24	1/8 NPT
	FE-1006	1/8 NPT	1/8 NPT
	FE-1009	1/8 NPT	1/4-28 Zerk
	FE-1004M	M8 x 1.0	1/8 BSPT
	FE-1003M	M10 x 1.0	1/8 BSPT
	FE-1014M	1/8 BSPT	1/8 BSPT
	FE-1005M	M8 x 1.0	1/4 BSPT
FE-1006M	M10 x 1.0	1/4 BSPT	

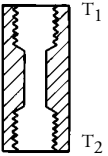
Illustration	New Model No.	T1	T2
 Female Thread Connector	FC-1009	5/16-24	5/16-24
	FC-1012	5/16-24	1/8 NPT
	FC-1018	1/8 NPT	1/8 NPT
	FC-1009M	M8 x 1.0	M8 x 1.0
	FC-1013M	M10 x 1.0	M10 x 1.0
	FC-1012M	M8 x 1.0	1/8 BSPT
	FC-1011M	M10 x 1.0	1/8 BSPT
FC-1014M	M14 x 1.5	M14 x 1.5	


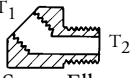
Illustration	Model No.	T1	T2
 90° Elbow	FE-1015	1/8 NPT	3/8-24
	FE-1016	1/8 NPT	7/16-24
	FE-1017	1/4 NPT	7/16-24

Illustration	Model No.	T1	T2
 45° Street Elbow	FE-1007	1/8 NPT	1/8 NPT
	FE-1013M	1/8 BSPT	1/8 BSPT

SWIVEL FITTINGS


Illustration	Model No.	T1	T2
 Swivel Adapter (Male thread)	FM-2003	1/8 NPSM	1/8 NPT
	FM-2004	1/4 NPSM	1/8 NPT
	FM-2005	1/4 NPSM	1/4 NPT


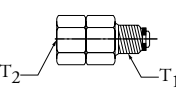
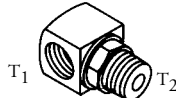
Illustration	Model No.	T1	T2
 Swivel Adapter (Female thread)	FM-2006	1/8 NPSM	1/8 NPT
	FM-2007	1/4 NPSM	1/4 NPT
	FM-2008	3/8 NPSM	3/8 NPT

Illustration	Model No.	T1	T2
	FM-2001M	M8 x 1.0	1/8 BSPT
	FM-2002M	1/8 BSPT	1/8 BSPT
	FM-2000	1/8 NPT	1/8 NPT
	FM-2000M	1/8 BSPT	1/8 BSPT

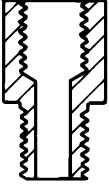
	FA-1007	5/16-24	
	FA-1008	1/8 NPT	
	FA-1000	1/4 NPT	
	FA-1001	5/16-24	
	FA-1009	5/16-24	
	FA-1003	3/8-24	
	FA-1005	1/8 NPT	
	FA-1004	1/8 NPT	
	FA-1023	5/16-24	
	FA-1024	1/8 NPT	
	FA-1025	1/8 NPT	
	FA-1026	1/8 NPT	
	FA-1007M	M8 x 1.0	
	FA-1006M	M10 x 1.0	
	FA-1013M	M8 x 1.0	
	FA-1015M	1/8 BSPT	
	FA-1014M	1/8 BSPT	
	FA-1016M	1/8 BSPT	
	FA-1011M	M10 x 1.0	
	FA-1010M	M10 x 1.0	
	FA-1017M	M8 x 1.0	
	FA-1023M	M8 x 1.0	
	FA-1012M	M10 x 1.0	
	FA-1017	1/8 BSPT	
FA-1018	M8 x 1.0		
FA-1020	5/16-24		
FA-1021	M8 x 1.0		
FA-1022	1/8 NPT		

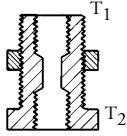
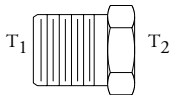
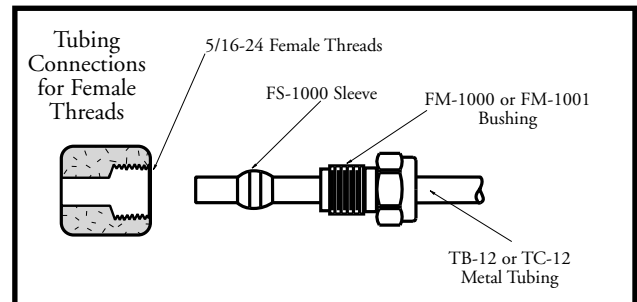
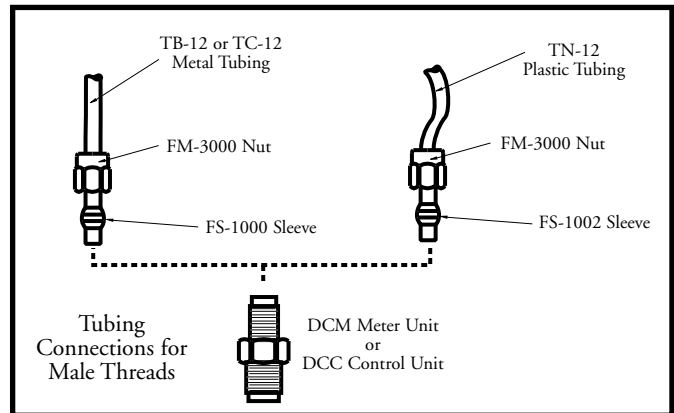




Illustration	Model No.	T1	T2
	FB-1002	5/16-24	5/16-24
	FB-1000	5/16-24	1/8 NPT
	FB-1002M	M8 x 1.0	M8 x 1.0
	FB-1003M	M10 x 1.0	M10 x 1.0
	FB-1000M	M8 x 1.0	1/8 BSPT
	FB-1001M	M10 x 1.0	1/8 BSPT

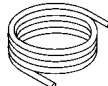
Illustration	Model No.	T1	T2
	FM-1003	3/8 NPT	1/8 NPT
	FM-1004	3/8 NPT	1/4 NPT
	FM-1005	1/2 NPT	1/8 NPT
	FM-1006	1/2 NPT	1/4 NPT
	FM-1007	1/2 NPT	3/8 NPT
	FM-1008	3/4 NPT	1/4 NPT



COMPRESSION FITTINGS







Illustration	Description	Model No.	Size	Model No.	Size
	3/8 Hex Bushing	FM-1001	5/16-24	FM-1001M	M8 x 1.0
	5/16 Hex Bushing	FM-1000		FM-1002M	M10 x 1.0
	Nut	FM-3000		FM-3000M	M8 x 1.0
	Metal Sleeve	FS-1000	5/32 (4mm)	FS-1004M	6 mm
	Nylon Half-Sleeve	FS-1002		-	-

TUBING - 12 FOOT LENGTHS

Illustration	Material	Model No.	Tube Size	Model No.	Tube Size
	Brass	TB-12	5/32 (4mm)	-	6mm
	Copper	TC-12		TC6-12M	
	Nylon	TN-12		TN6-12M	


Fittings & Hoses

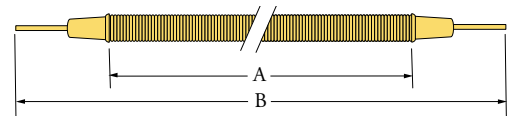
JUNCTIONS

Illustration	No. of Ports	Inch Threads		Metric Threads	
		Model No.	Thread Size	Metric Model No.	Thread Size
	2	J-02	5/16-24	J-02M	M8 x 1.0
	3	J-03		J-03M	
	4	J-04		J-04M	
	4	JS-04		JS-04M	
	5	JS-05		JS-05M	
	6	JS-06		JS-06M	
	7	JS-07		JS-07M	
	8	JS-08		JS-08M	
	9	JS-09		JS-09M	
	4	JD-04		JD-04M	
	6	JD-06		JD-06M	
	8	JD-08		JD-08M	
	10	JD-10	JD-10M		
	3	JH-03	1/8 NPT (T ₁) x 5/16-24 (T ₂)	JH-03M	1/8 BSPT (T ₁) x M8 x 1.0 (T ₂)
	4	JH-0402		JH-0402M	

HOSES




Model No.	Diameter	Dimensions (in.)	
		A	B
H-404	5/32 (4 mm)	4	6
H-405		5	7
H-406		6	8
H-407		7	9
H-408		8	10
H-409		9	11
H-410		10	12
H-412		12	14
H-414		14	16
H-416		16	18
H-418		18	20
H-420		20	22
H-422		22	24
H-424		24	26
H-427		27	29
H-430		30	32
H-433		33	35
H-436		36	38
H-440		40	42
H-444		44	46
H-448	48	50	
H-452	52	54	
H-456	56	58	
H-460	60	62	
H-612	6 mm Diameter Hose	12	14
H-624		24	26
H-636		36	38
H-648		48	50

Illustration	Model No.	Thread
	FM-5000	1/8 NPT
	FM-5001	1/4 NPT




Accessories


PLUGS

Illustration	Inch Threads		Metric Threads	
	Model No.	Size	Model No.	Size
	FP-1003	5/16-24	FP-1003M	M8 x 1.0
			FP-1006M	M10 x 1.0
	FP-1002	5/16-24	FP-1004M	M8 x 1.0
	FP-1001	1/8 NPT	FP-1001M	1/8 BSPT
			FP-1009M	





TUBING CLIPS

Illustration	New Model No.	Tube Size
		
1	FT-1001M	5/32 (4mm)
2	FT-1004M	
3	FT-1006M	
1	FT-1003M	6 mm
2	FT-1005M	

PRESSURE GAUGES

Illustration	Model No.	Connection Thread	Pressure Range	Model No.	Connection Thread	Pressure Range
	MG-1000	1/8 BSPT Rear Mount	0-15 Bar	MG-1002	1/8 BSPT Bottom Mount	0-15 Bar
	MG-1001		0-35 Bar	MG-1003		0-35 Bar

CHECK VALVES - 5 PSI

Illustration	Flow Direction Towards	Inch Threads			Metric Threads		
		Model No.	Thread Size (T1)	Thread Size (T2)	Metric Model No.	Thread Size (T1)	Thread Size (T2)
	T2	FV-1001	1/8 NPT	5/16-24	FV-1006M	1/8 BSPT	M8 x 1.0
					FV-1007M	1/8 BSPT	M10 x 1.0
	T1	FV-1000	1/8 NPT	5/16-24	FV-1004M	1/8 BSPT	M8 x 1.0
					FV-1003M	1/8 BSPT	M10 x 1.0
	T1	FV-1002	1/8 NPT	5/16-24	FV-1002M	1/8 BSPT	M8 x 1.0
					FV-1005M	1/8 BSPT	M10 x 1.0
	T2	FV-1008	1/8 NPT	5/16-24	FV-1008M	1/8 BSPT	M8 x 1.0
					FV-1009M	1/8 BSPT	M10 x 1.0

PRO/MARK INDUSTRIALS

Lubrication Systems & Devices

Div. R.D. Lewis Sales Limited

Brass fittings commonly used on orifice controlled, centralized oil lubrication systems such as Bijur, Shawa, Trico, Lube USA, etc.

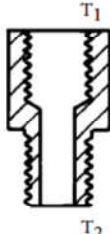
Illustration	New Model No.	T1	T2
 Adapter	FA-1007	5/16-24	1/8 NPT
	FA-1008	1/8 NPT	1/8 NPT
	FA-1000	1/4 NPT	1/8 NPT
	FA-1001	5/16-24	5/16-24
	FA-1009	5/16-24	1/4-28 Zerk
	FA-1003	3/8-24	1/8 NPT
	FA-1005	1/8 NPT	5/16-24
	FA-1004	1/8 NPT	1/4-28 Zerk
	FA-1023	5/16-24	1/8 BSPT
	FA-1024	1/8 NPT	M6 x 1.0
	FA-1025	1/8 NPT	M8 x 1.25
	FA-1026	1/8 NPT	M10 x 1.5
	FA-1007M	M8 x 1.0	1/8 BSPT
	FA-1006M	M10 x 1.0	1/8 BSPT
	FA-1013M	M8 x 1.0	1/4 BSPT
	FA-1015M	1/8 BSPT	M10 x 1.0
	FA-1014M	1/8 BSPT	M8 x 1.0
	FA-1016M	1/8 BSPT	1/8 BSPT
	FA-1011M	M10 x 1.0	M8 x 1.0
	FA-1010M	M10 x 1.0	PT 1/4
	FA-1017M	M8 x 1.0	M6 x 1.0
	FA-1023M	M8 x 1.0	M10 x 1.0
FA-1012M	M10 x 1.0	M10 x 1.0	
FA-1017	1/8 BSPT	1/8 NPT	
FA-1018	M8 x 1.0	1/8 NPT	
FA-1020	5/16-24	M8 x 1.0	
FA-1021	M8 x 1.0	5/16-24	
FA-1022	1/8 NPT	1/8 BSPT	

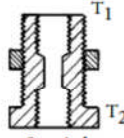
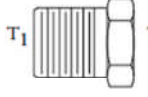
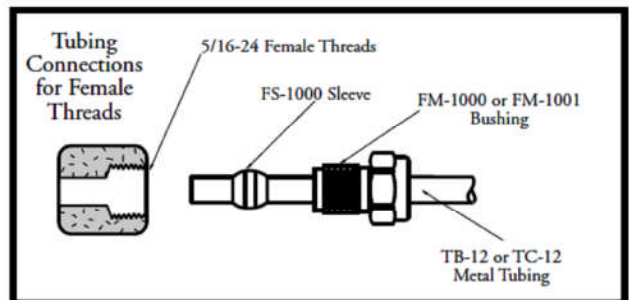
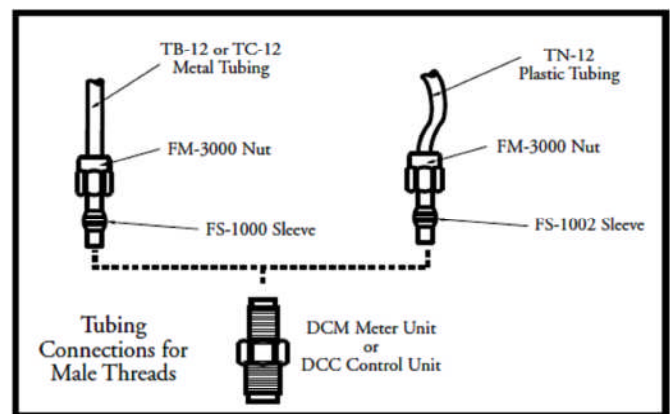




Illustration	Model No.	T1	T2
 Straight Bulkhead Connector	FB-1002	5/16-24	5/16-24
	FB-1000	5/16-24	1/8 NPT
	FB-1002M	M8 x 1.0	M8 x 1.0
	FB-1003M	M10 x 1.0	M10 x 1.0
	FB-1000M	M8 x 1.0	1/8 BSPT
	FB-1001M	M10 x 1.0	1/8 BSPT


Illustration	Model No.	T1	T2
 Reducer Bushing	FM-1003	3/8 NPT	1/8 NPT
	FM-1004	3/8 NPT	1/4 NPT
	FM-1005	1/2 NPT	1/8 NPT
	FM-1006	1/2 NPT	1/4 NPT
	FM-1007	1/2 NPT	3/8 NPT
	FM-1008	3/4 NPT	1/4 NPT



COMPRESSION FITTINGS

Illustration	Description	Model No.	Size	Model No.	Size
	3/8 Hex Bushing	FM-1001	5/16-24	FM-1001M	M8 x 1.0
	5/16 Hex Bushing	FM-1000		FM-1002M	M10 x 1.0
	Nut	FM-3000		FM-3000M	M8 x 1.0
	Metal Sleeve	FS-1000	5/32 (4mm)	FS-1004M	6 mm
	Nylon Half-Sleeve	FS-1002		-	-

TUBING - 12 FOOT LENGTHS

Illustration	Material	Model No.	Tube Size	Model No.	Tube Size
	Brass	TB-12	5/32 (4mm)	-	6mm
	Copper	TC-12		TC6-12M	
	Nylon	TN-12		TN6-12M	

PRO/MARK INDUSTRIALS

Div. R.D. Lewis Sales Limited

Lubrication Systems & Devices

P.O. Box 26028, Cambridge, Ont. N1R 8E8 Phone (519) 621-0479 (800) 263-9865 Fax. (519) 621-1972 E-mail: sales@promarkindstrials.com